

PROJECT: _____

QUANTITY 215A

ITEM NO.:

28



1/2 – 1-1/4 H.P. DISPOSER MODELS

Heavy-duty disposer designed for continuous operation in restaurants, hotels, hospitals and cafeterias. Food waste including steak bones is quickly and efficiently removed with this labor-saving, self-cleaning, environmentally sound disposer.

SPECIFICATIONS

- **Grind Chamber:** Corrosion Resistant Stainless Steel
- **Mounting:** 3/4" (19.1 mm) rubber mounting above grinding chamber isolates sound and eliminates vibration. Mounting is enclosed in chrome plated covers for sanitation and appearance.
- **Motor:** 1/2 – 1-1/4 HP Induction Motor, 1725 RPM, totally enclosed to provide protection against outside moisture. Controlled power air flow cools motor for efficiency and longer life. Built-in thermal overload protection.
- **Cutting Elements:** Stationary and rotating shredding elements made from cast nickel chrome alloy for long life and corrosion resistance, designed for reverse action grinding.
- **Main Bearings:** Double-tapered Timken roller bearings provide a shock absorbing cushion.
- **Motor Seals:** Triple lip seal protects motor from water damage. Secondary spring-loaded oil seal provides double protection against water and loss of grease.
- **Finish:** All Stainless Steel and Chrome plated. Paint-free for lasting sanitation.
- **Warranty:** 1 year full warranty from date of installation.
- **A Disposer Package Includes:** 1 Mounting/Bowl Assembly, 1 Electrical Control, 1 Syphon Breaker, 1 Solenoid Valve, and 1 Flow Control Valve. The standard Flow Control Valve will be sent with the unit unless the optional valve is specified.



MODEL & HORSEPOWER/ELECTRICAL REQUIREMENTS

<input type="checkbox"/> SS-50 1/2 H.P.	<input type="checkbox"/> 115/208-230V, 60 Hz, 1 Ph, 8.4/4.0/4.2 amps, UL	<input type="checkbox"/> 115/208-230V, 60 Hz, 1 Ph, 8.4/4.0/4.2 amps, CSA
	<input type="checkbox"/> 208-230/460V, 60 Hz, 3 Ph, 2.0/2.2/1.1 amps, UL	<input type="checkbox"/> 208-230/460V, 60 Hz, 3 Ph, 2.0/2.2/1.1 amps, CSA
<input type="checkbox"/> SS-75 3/4 H.P.	<input type="checkbox"/> 115/208-230V, 60 Hz, 1 Ph, 10.0/4.2/5.0 amps, UL	<input type="checkbox"/> 115/230V, 50 Hz, 3 Ph, 7.7/3.7 amps
	<input type="checkbox"/> 208-230/460V, 60 Hz, 3 Ph, 2.5/3.0/1.5 amps, UL	<input type="checkbox"/> 230/460V, 50 Hz, 3 Ph, 2.7/1.4 amps
	<input type="checkbox"/> 115/208-230V, 60 Hz, 1 Ph, 10.4/4.3/5.0 amps, CSA	<input type="checkbox"/> 380V, 50 Hz, 3 Ph, 1.1 amps
	<input type="checkbox"/> 208-230/460V, 60 Hz, 3 Ph, 2.5/3.0/1.5 amps, CSA	
<input type="checkbox"/> SS-100 1 H.P.	<input type="checkbox"/> 115/208-230V, 60 Hz, 1 Ph, 11.6/5.1/5.7 amps, UL	<input type="checkbox"/> 208-230/460V, 60 Hz, 3 Ph, 2.2/3.0/1.5 amps, CSA
	<input type="checkbox"/> 208-230/460V, 60 Hz, 3 Ph, 2.2/3.0/1.5 amps, UL	<input type="checkbox"/> 120/208-240V, 60 Hz, 1 Ph, 11.6/5.1/5.7 amps, NOM
	<input type="checkbox"/> 115/208-230V, 60 Hz, 1 Ph, 11.6/5.1/5.7 amps, CSA	<input type="checkbox"/> 100/200-230V, 50/60 Hz, 1 Ph, 10.4/5.2/5.4 amps
<input type="checkbox"/> SS-125 1-1/4 H.P.	<input type="checkbox"/> 115/208-230V, 60 Hz, 1 Ph, 12.8/5.9/6.6 amps, UL	<input type="checkbox"/> 115/208-230V, 60 Hz, 1 Ph, 12.8/5.9/6.6 amps, CSA
	<input type="checkbox"/> 208-230/460V, 60 Hz, 3 Ph, 2.6/3.3/1.9 amps, UL	<input type="checkbox"/> 208-230/460V, 60 Hz, 3 Ph, 2.6/3.3/1.9 amps, CSA

NOTE: All amp ratings denote amp draw during a grind load.

ELECTRICAL CONTROLS



- AS-101 Control Center "Aqua Saver" (Auto-Reversing)



- CC-101 Control Center (Auto-Reversing)



- CC-202 Control Center (Auto-Reversing)



- Manual Reverse Switch (Dual Direction)



- Manual Switch (Single Direction)

Our products appear on *The KCL CADalog* CD-ROM based CAD Foodservice Symbol Library. More information is available from **Kochman Consultants, Ltd.** at www.kclcad.com.



4700 21st STREET
RACINE, WI 53406
TEL: 800-845-8345
FAX: 262-554-3620

www.insinkerator.com





The Emerson logo is a trademark and a service mark of Emerson Electric Co.



DISPOSER MOUNTING ASSEMBLIES (choose one)



Bowl Mounts

-  Type A Sink Bowl Assembly: Includes bowl, water nozzle(s), bowl cover, splash baffle
-  Type B Sink Bowl Assembly: Includes bowl, water nozzle(s), silver guard, splash baffle
-  Type C Sink Bowl Assembly: Includes bowl, water nozzle(s), splash baffle

Sink Bowl Assembly Size

- 12" (304.8 mm) with one adjustable water nozzle
- 15" (381.0 mm) with one adjustable water nozzle
- 18" (457.2 mm) with two adjustable water nozzles

Collar Mounts

-  #5 Sink Flange Mounting Assemblies for 3-1/2" – 4" (88.9 mm – 101.6 mm) sink opening (support legs are recommended)
-  #6 Collar Adaptor for welding into trough, provides 6-5/8" (168.3 mm) opening, includes splash baffle
-  #7 Collar Adaptor for welding into sink, provides 6-5/8" (168.3 mm) opening, includes splash baffle and stopper

DIMENSIONS

IMPORTANT: Use dimension chart below for adaptor height in place of InSinkEerator bowl sink height when mounting directly to a sink.

Bowl Sinks	Flange O.D. X	Work Table Hole Y	Flange I.D. Z	Height
12" (304.8 mm)	13-1/2" (342.9 mm)	12-1/4" (311.2 mm)	12" (304.8 mm)	6-1/2" (165.1 mm)
15" (381 mm)	16-1/2" (419.1 mm)	15-1/4" (387.4 mm)	15" (381.0 mm)	6-1/2" (165.1 mm)
18" (457.2 mm)	19-1/2" (495.3 mm)	18-1/4" (463.6 mm)	18" (457.2 mm)	6-1/2" (165.1 mm)
Adaptors	X	Y	Z	Height
No. 5	Fits Standard Sink Opening: 3-1/2" – 4" (88.9 mm – 101.6 mm)			2-3/4" (69.9 mm)
No. 6	7-13/16" (198.4 mm)	6-7/8" (174.6 mm)	6-5/8" (168.3 mm)	1-3/16" (30.2 mm)
No. 7	9-1/8" (231.8 mm)	7-7/8" (200.0 mm)	7-5/8" (193.7 mm)	2-1/16" (52.4 mm)

NOTE:

- Adaptors are available upon request for all competitor sink bowls or cones.
- Please have sink bowl/cone type with the necessary dimensions when ordering adaptors.

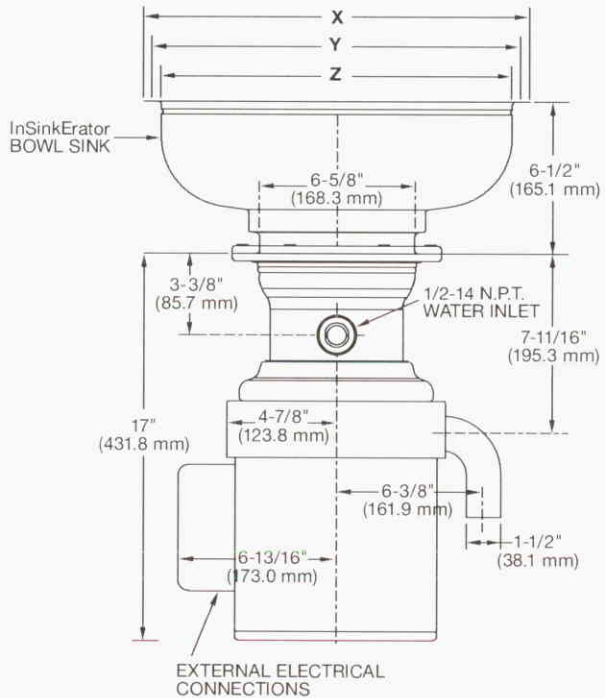

RECOMMENDED INSTALLATION

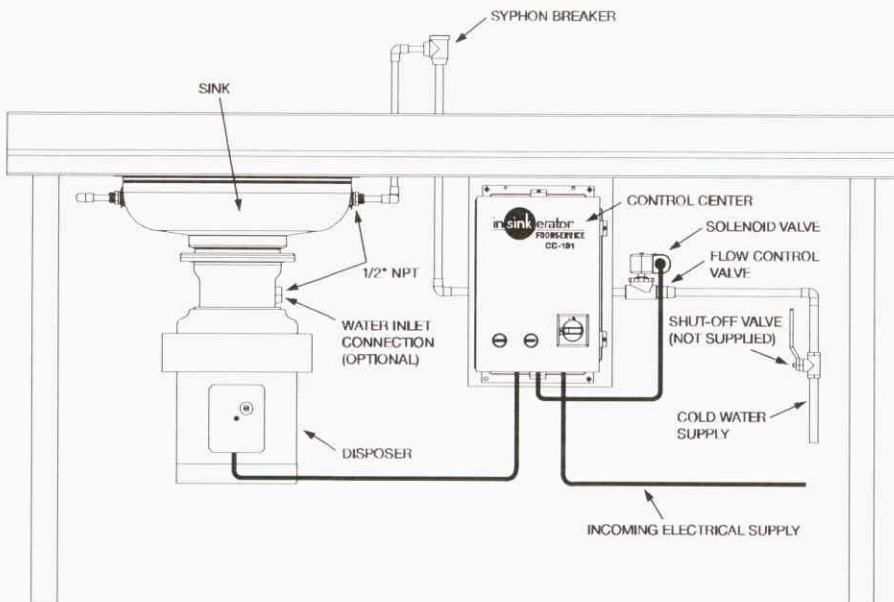

RECOMMENDED WATER USAGE

	Standard	Optional
SS-50	3 GPM (11.4 LPM)	N/A
SS-75	3 GPM (11.4 LPM)	N/A
SS-100	5 GPM (18.9 LPM)	3 GPM (11.4 LPM)
SS-125	5 GPM (18.9 LPM)	3 GPM (11.4 LPM)

For additional information, see Foodservice Product Information Binder.